

Modus

PEDRALI®

MDA_110 - MDA_140 - MDA_175 - MDA_240

DESIGN
Pedrali R&D

100%
MADE IN
ITALY

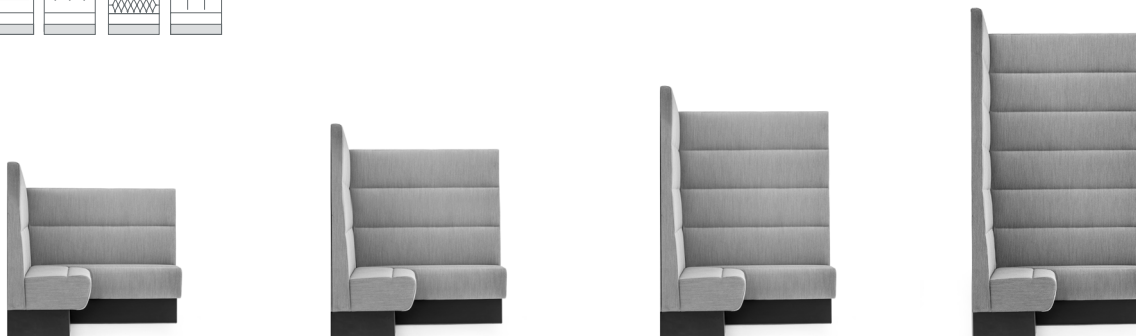
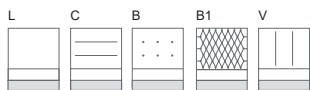

EN: Modular corner bench with seat and backrest upholstered with fabric-covered fire-retardant polyurethane foam and extruded aluminium plinth

IT: Panca modulare angolare con seduta e schienale imbottiti con schiumato poliuretano ignifugo rivestito in tessuto e zoccolo in estruso di alluminio

DE: Modulare Eckbank mit Sitz und Rückenlehne, gepolstert mit stoffbezogenem, feuerhemmendem Polyurethanschaum und Sockel aus stranggepresstem Aluminium

FR: Banc d'angle modulaire avec assise et dossier garnis de mousse polyuréthane ignifugée recouverte de tissu et socle en aluminium extrudé

ES: Banco modular de esquina con asiento y respaldo tapizados con espuma de poliuretano ignífuga recubierta de tela y zócalo de aluminio extruido

mm - in

• MDA_110

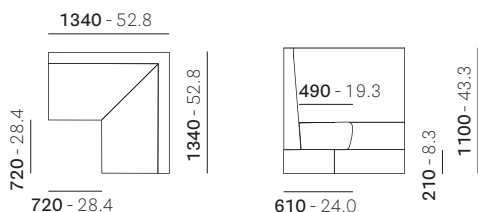

Disassembled
Da assemblare



mc 0,88
ft³ 31.1

• MDA_140

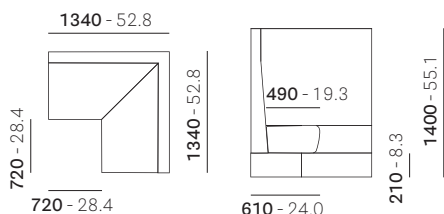

Disassembled
Da assemblare



mc 1,06
ft³ 37.4

• MDA_175

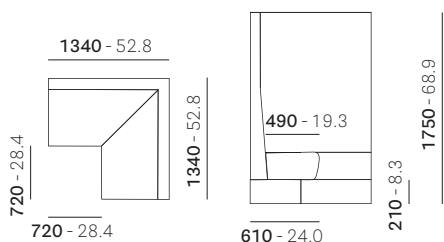

Disassembled
Da assemblare



mc 1,21
ft³ 42.7

Reproduction of this document is strictly prohibited without prior written authorisation from Pedrali SpA. Sizes, weights and finishes may change without previous notice.
È vietata la riproduzione del seguente documento senza previa autorizzazione scritta da parte di Pedrali SpA. Dimensioni, pesi e finiture possono variare senza alcun preavviso.

ST_MODUS_MDA_110_MDA_140_MDA_175_MDA_240_2022.0

mm - in
• MDA_240

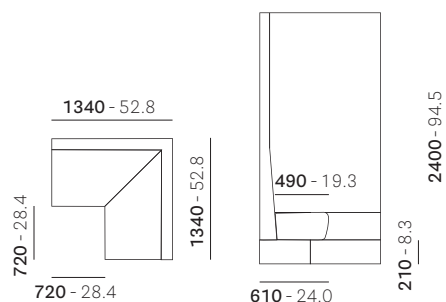

Disassembled
Da assemblare

mc 1,455 **kg 200**
ft³ 51.4 lb 440.9

MATERIALS

Materiali
Materialien
Matériaux
Materiales

• FRAME - TELAIO - STRUKTUR - STRUCTURE - ARMAZÓN

EN: Steel structure

IT: Struttura in acciaio
DE: Stahlkonstruktion
FR: Structure en acier
ES: Estructura de acero

FRAME FINISH - FINITURA TELAIO - AUSFÜHRUNG DES GESTELL - FINITIONS STRUCTURE - ACABADO ARMAZÓN

EN: Powder coating

IT: Verniciato con polvere
DE: Pulverbeschichtet
FR: Époxy à poudre
ES: Barnizado con polvo



NERO

• BACKREST - SCHIENALE - RÜCKENLEHNE - DOSSIER - RESPALDO

EN: Wooden frame, padded with flexible polyurethane (density 60 kg/m³), flame retardant (class 1IM, Crib 5), covered with fabric

IT: Struttura in legno, imbottito in poliuretano flessibile (densità 60 kg/m³), ignifugo (classe 1IM, Crib 5), rivestita in tessuto
DE: Holzrahmen, gepolstert mit flexiblem Polyurethan (Dichte 60 kg/m³), schwer entflammbar (Klasse 1IM, Krippe 5), mit Stoff bezogen
FR: Cadre en bois, rembourré de polyuréthane flexible (densité 60 kg/m³), ignifugé (classe 1IM, Crib 5), recouvert de tissu
ES: Marco de madera, acolchado de poliuretano flexible (densidad 60 kg/m³), ignifugo (clase 1IM, Crib 5), recubierto de tela

EN: Available finish: plain (L), with horizontal stitching (C), with vertical stitching (V)

IT: Finitura disponibile: liscio (L), con cuciture orizzontali (C), con cuciture verticali (V)

• SEAT - SEDILE - SITZFLÄCHE - ASSISE - ASIENTO

EN: Wooden frame with steel reinforcements, padded with flexible polyurethane (density 60 kg/m³), flame retardant (class 1IM, Crib 5), covered with fabric

IT: Struttura in legno con rinforzi in acciaio, imbottito in poliuretano flessibile (densità 60 kg/m³), ignifugo (classe 1IM, Crib 5), rivestita in tessuto
DE: Holzrahmen mit Stahlverstärkung, gepolstert mit flexiblem Polyurethan (Dichte 60 kg/m³), flammhemmend (Klasse 1IM, Crib 5), mit Stoff bezogen
FR: Cadre en bois avec renforts en acier, rembourré en polyuréthane flexible (densité 60 kg/m³), ignifugé (classe 1IM, Crib 5), recouvert de tissu
ES: Marco de madera con refuerzos de acero, acolchado de poliuretano flexible (densidad 60 kg/m³), ignifugo (clase 1IM, Crib 5), recubierto de tela

• FABRIC - TESSUTO - STOFF - TISSU - TEJIDO

Cat. A, C (Excluding / Escluso C36÷C39, C83÷C89, C100÷C101, C110÷C122), D40÷D44, E, G, H, N

EN: For more information see finishing legend on the website

IT: Per maggiori informazioni vedere legenda finiture sul sito web

MDA_110 - MDA_140 - MDA_175 - MDA_240

DESIGN
Pedrali R&D

• BASEBOARD - ZOCCOLO - SOCKELLEISTEN - SOCLE - ZÓCALO

EN: Extruded aluminium
IT: Estruso di alluminio
DE: Strangepresstes Aluminium
FR: Aluminium extrudé
ES: Aluminio extruido

BASEBOARD FINISH - FINITURA ZOCCOLO - AUSFÜHRUNG DER SOCKELLEISTE - FINITIONS SOCLE - ACABADO ZÓCALO

EN: Matt black anodised
IT: Anodizzato nero opaco
DE: Mattschwarz eloxiert
FR: Anodisé noir mat
ES: Anodizado negro mate



NERO

EN: Satin
IT: Satinato
DE: Satin
FR: Satin
ES: Satén



AS

EN: Antique brass
IT: Ottone anticato
DE: Messing Antik
FR: Laiton vieilli
ES: Latón antiguo



OA2

• FEET - PIEDINI - GLEITER - PATINS - TACOS

EN: Adjustable black polypropylene feet, Ø 30 mm
IT: Piedini in polipropilene regolabili neri, Ø 30 mm
DE: Verstellbare Füße aus schwarzem Polypropylen, Ø 30 mm
FR: Pieds réglables en polypropylène noir, Ø 30 mm
ES: Pies ajustables de polipropileno negro, Ø 30 mm

ACCESSORIES

Accessori
Zubehörteile
Accessoires
Accesorios

code MD5_110x134 - MD5_140x134 - MD5_175x134

EN: Laminate panel with ABS edge, thickness 30 mm, available in the following colours
IT: Pannello in laminato con bordo ABS, spessore 30 mm, disponibile nei colori
DE: Laminatplatte mit ABS-Kante, Dicke 30 mm, erhältlich in folgenden Farben
FR: Panneau stratifié avec bord en ABS, épaisseur 30 mm, disponible dans les couleurs suivantes
ES: Panel laminado con borde de ABS, espesor 30 mm, disponible en los siguientes colores

EN: Only for bench height 1000 and 1300 mm
IT: Solo per panche altezza 1000 e 1300 mm

FINISH - FINITURA - AUSFÜHRUNG - FINITIONS - ACABADO



312



421



1016



406_0020

MDA_110 - MDA_140 - MDA_175 - MDA_240

DESIGN
Pedrali R&D

• MD5_110x134

30 - 1.2

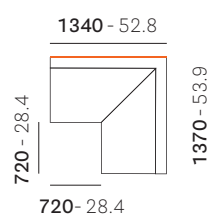
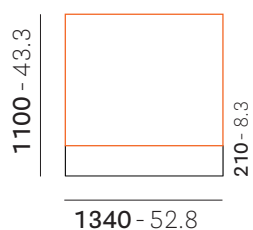
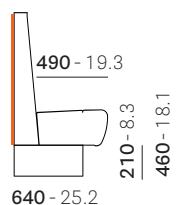

• MD5_140x134

30 - 1.2

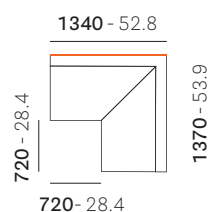
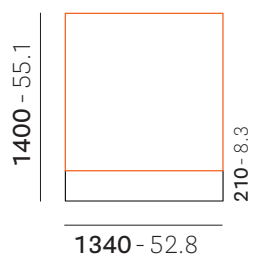
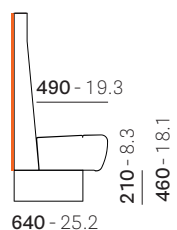

• MD5_175x134

30 - 1.2

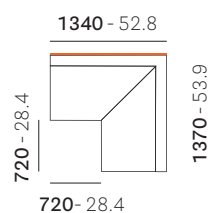
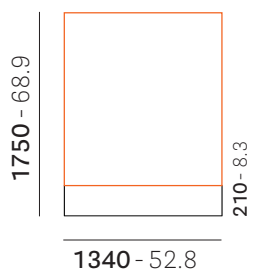
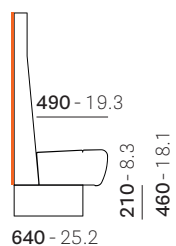

Reproduction of this document is strictly prohibited without prior written authorisation from Pedrali SpA. Sizes, weights and finishes may change without previous notice.
È vietata la riproduzione del seguente documento senza previa autorizzazione scritta da parte di Pedrali SpA. Dimensioni, pesi e finiture possono variare senza alcun preavviso.

ST_MODUS_MDA_110_MDA_140_MDA_175_MDA_240_2022.0

MDA_110 - MDA_140 - MDA_175 - MDA_240

DESIGN
Pedrali R&D

REGULATIONS AND CERTIFICATES

Normative e Certificazioni
Bestimmungen und Zertifikat
Normatives et certifications
Normativas y certificados

• ENVIRONMENTAL IMPACT - IMPATTO AMBIENTALE - UMWELTBELASTUNG - IMPACT DUR L'ENVIRONNEMENT - IMPACTO AMBIENTAL

MATERIAL Materiale	Kg WEIGHT Peso	% TOTAL ITEM Totale articolo	MATERIAL RECYCLABILITY Riciclabilita' del materiale	% MINIMUM RECYCLED AT ORIGIN Minima riciclato all'origine	% RECYCLABLE END OF PRODUCT LIFE Riciclabile fine vita prodotto
Steel Acciaio	21,908	10,94	YES	33,2	100
Extruded aluminium Alluminio estruso	3,71	1,85	YES	0	100
Polyethylene Polietilene	0,092	0,05	YES	0	100
Polyurethan foam Poliuretano espanso	25,64	12,81	NO	0	0
Chipboard Truciolare	146,28	73,06	NO	90	0
Fabric Tessuto	2,58	1,29	NO	0	0
TOTAL TOTALE	200,21 Kg	--	--	69,4 %	12,8 %

EN: Percentages referred to MDA_240

IT: Percentuali riferite al MDA_240

• COMPANY CERTIFICATIONS - CERTIFICAZIONI AZIENDALI - UNTERNEHMENSZERTIFIZIERUNGEN - CERTIFICATIONS D'ENTREPRISE - CERTIFICACIONES DE LA EMPRESA

ISO 14001
Environmental management system
Sistema di gestione ambientale

ISO 9001
Quality management system
Sistema di gestione della qualità

